

ABM

ergonomic style

Levers *synto*[™] / *syntoEvo*[™] / *syntoRace*[™]



Fitting Instruction and Safety Advices



Attention



Important Safety Advices:

- Working on clutch or braking-system is safety-relevant. Improperly fitting can reduce your motorcycle's driveability and may be a risk of serious injuries or death. You should do this work only if you're qualified and in possession of an official workshop manual as well as all relevant service bulletins. Otherwise this mounting is recommended to be done, or at least checked, by a qualified workshop.
- Adhere to the workshop manual for all works and tightening torques on original parts.
- It's important to be close to all functions and adjustments before starting a ride, to assure a proper function of *synto*-levers.
- There might be some adjustment-levels which aren't usable, depending on motorcycle model.
- Choose your desired adjustment on levers and check clutch and brake for flawless function.
- Memorise these settings and monitor them before each ride, especially when other persons had access to your bike.
- It's on your own responsibility to check this product regularly for service or replacement.
- Please mind that *synto*-lever is a safety-relevant part on you motorcycle. Always check levers after any kind of accident or tumbled bike. Immediately replace whole *synto*-lever at least sign of damage. Never try to repair or straighten a damaged lever.
- Always check your local laws for using aftermarket parts on your bike.
- This accessory was designed and approved for a series-production vehicle. ABM[®] Fahrzeugtechnik GmbH disclaims any liability or warranty for all damages that occur by improper fitting, lacking maintenance or incompatibility to accessories which are not approved by ABM[®]

1 Work Preparation

- Read safety advices and fitting instruction completely and carefully.
- Park motorcycle on a firm and flat surface and protect it from tumbling down or rolling away.
- Keep children and pets away from the working range.
- Protect temporarily removed parts from damage.
- Accurately record demounted parts' and related bolts' locations. If not otherwise mentioned, these parts are reassembled in same sequence and locations as before

2 Assembly of parts for *syntoEvo* / *syntoRace*



- Choose your desired lever-extension (long or short), insert it into synto-lever and fix it, with included bolts and wrench.
- Don't torque these bolt too strong, otherwise the thread will be damaged.

3 Fitting adapter, general advices

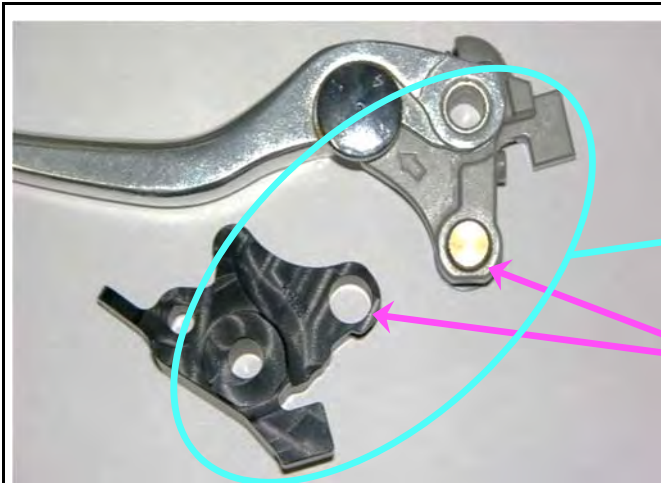

- Remove original levers completely.
- Compare each original adapter to the new one.
- Swap all small parts, which aren't scope of delivery, as shown in the picture.

3.1 Fitting adapter, make BH11 / KH11 / BH41 / KH55

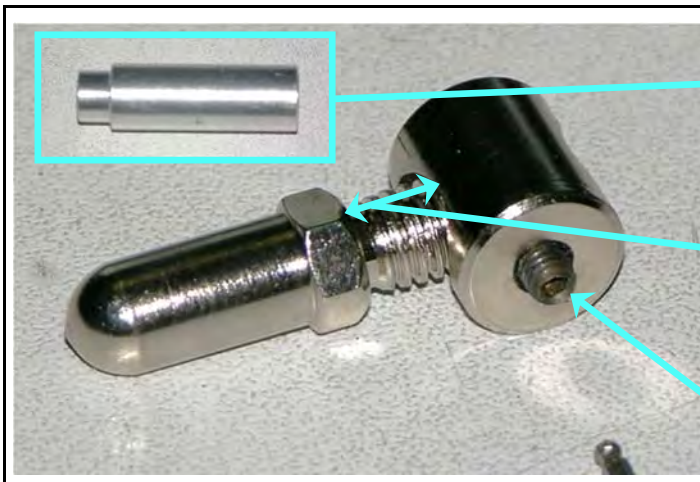

- Use pin punch (special tooling) to demount original Brake- and clutch-lever.
- Clearance needs to be adjusted in each case, according to the workshop manual.
- Heat the grub bolt to unblock thread-locker.

3.2 Fitting adapter, make BH18 / BH20 / BH21 / BH29

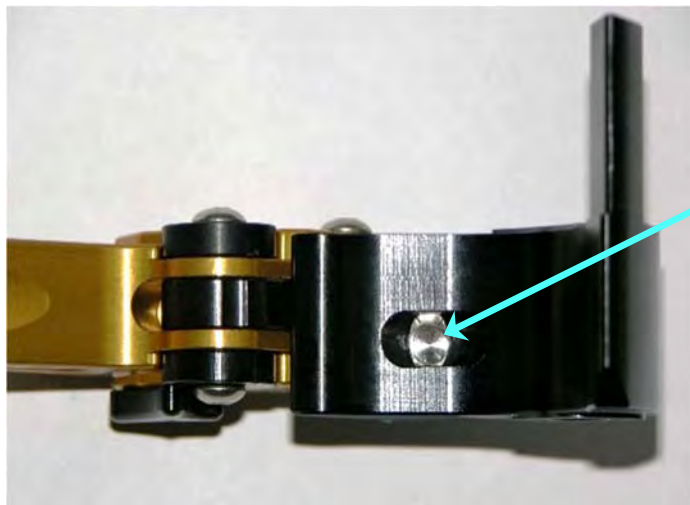

- This bore needs to match the slot.
- Grease cylinder's rod and slip it into the bore, when mounting lever.

3.3 Fitting adapter, make BKH1 und BH27 for BMW models

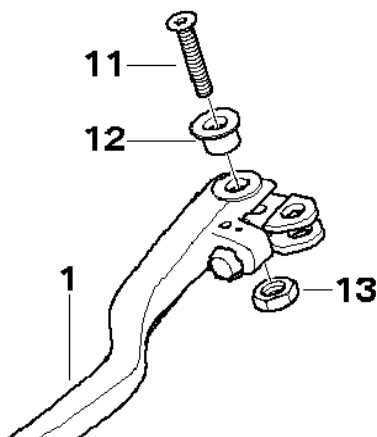

- Loosen bolt [11] and counter-nut [13], according to the workshop manual, to release lever from cylinder assy.
- Press original sleeved brass bushing [12] out of lever. Thus enables you to demount actuator [10] and spring [9] from original lever.

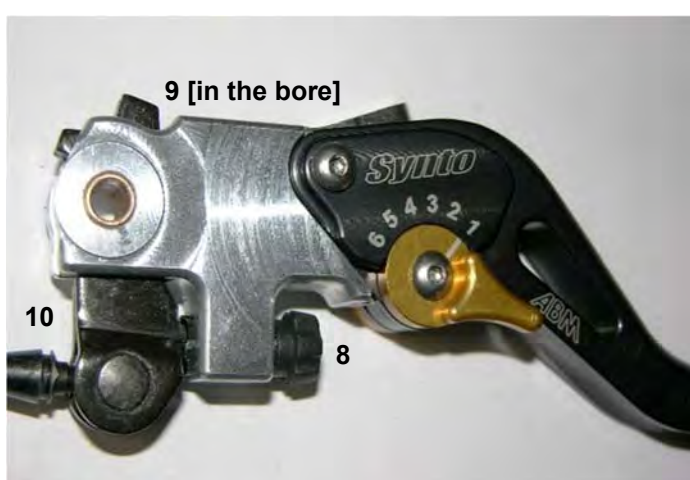

- Demount original adjustment screw [8] at last. Thereto remove plastic cap from adjustment screw and demount screw.
- Fit demounted parts, in reverse order, on synto-lever. All demounted parts will be reused.

3.4 Fitting adapter, make KH37 for BMW models



- Loosen bolt and counter-nut to release lever from cylinder assy. Unhinge clutch cable from lever.
- Press brass bushing out of lever (watch out for the spring) and release original lever from clutch adapter.
- Insert synto-lever, together with spring, into original clutch adapter and press brass bushing into lever again. Apply some grease on the bush before.
- Remount lever into holder and hinge clutch cable again.

3.5 Fitting adapter, make KH39 / KH54 for BMW

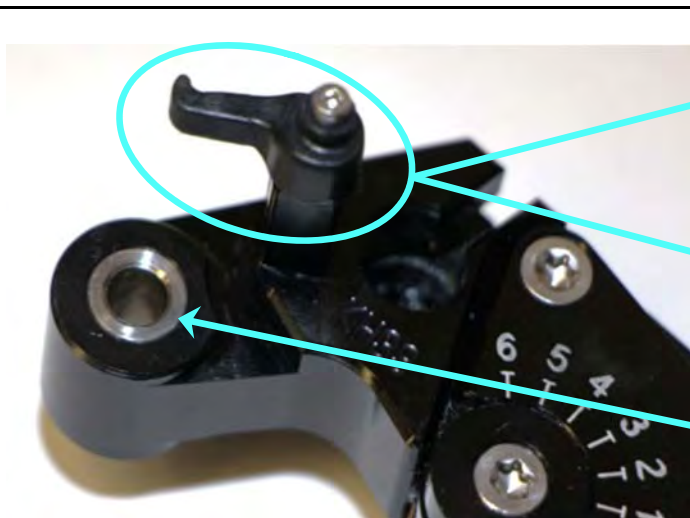

KH39: Requirement for S1000R and S1000RR: The actuating part for the clutch switch of the original lever must be mounted.

KH54: Requirement for S1000XR: The actuating part for the clutch switch of the original lever must be mounted.

The delivered guide bushing for S1000RR as of 2015, S1000R and S1000XR must be mounted with the lever.



- Requirement for S1000RR until 2014: The original guide bushing must be used.

3.6 Fitting adapter, make BH32 / KH44 for BMW

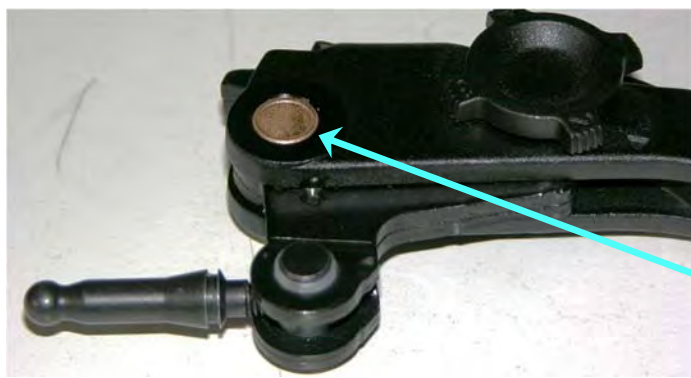

Advice: It may be necessary to remove mirrors and hand-protectors before proceeding on levers.

- Press brass bushing out of the lever.

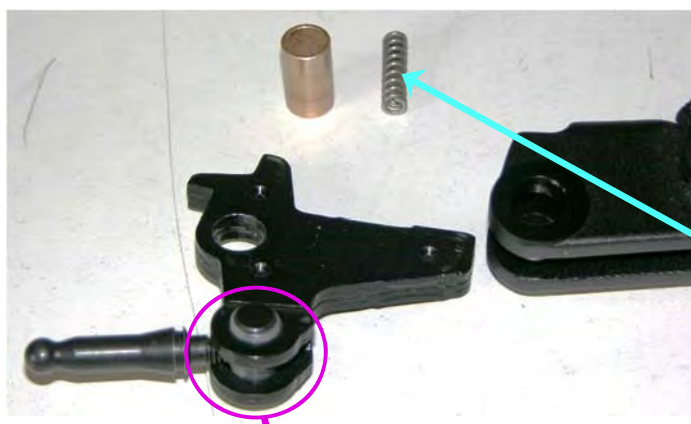

- Charily separate adapter from lever.
- There is no further use for the original spring.



- Precisely measure the shown distance with a sliding calliper and record this measurement.

Attention: These distances are different between both levers.

Brake lever data: _____ mm

Clutch lever data: _____ mm



- Heat the grub bolt sufficiently with a hot air gun to unblock thread-locker and demount it.

Attention: Careful heating required, if overheated pivot pin and bushing may be damaged.

General Fitting Instruction Levers *synto*[™] / *syntoEvo*[™] / *syntoRace*[™]



- Screw pushrod out of...
- ...pivot pin and...
- ...remove both parts from the original adapter

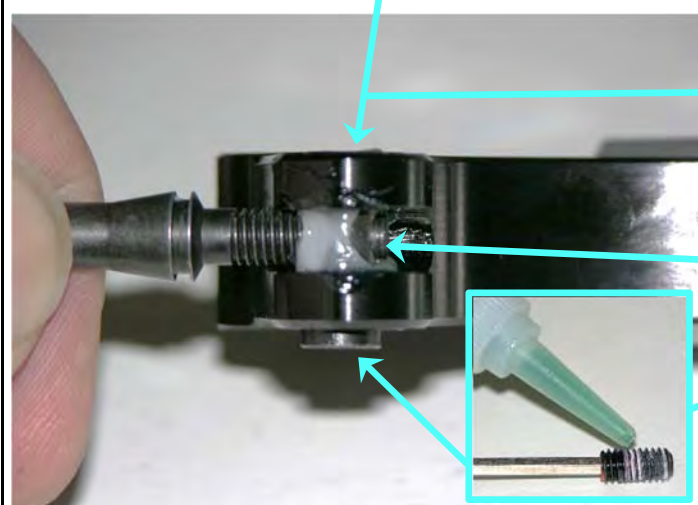

- Grease pivot pin and slip it into the new adapter, in same alignment as before (with grub bolt's thread facing down).
- Screw pushrod into pivot pin until you reach exactly the measured distance.
- Fix it with grub bolt and apply some heavy thread-locking adhesive before.



- Coat additional grease between all moving parts.
- Press original brass bushing into adapter.



- Slip new Lever into armature, with slight pressure. Assure the pushrod snaps into hydraulic cylinder's match.
- Fix lever with original bolt and counter-nut. Torque down the nut only slightly.
- Remount mirrors and hand-protectors, if demounted before.

3.7 Fitting clutch-adapter for Honda

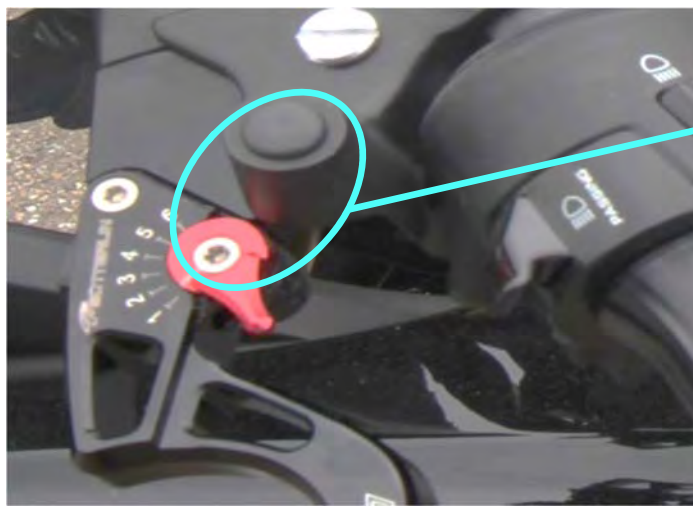

- On Honda models CBF 600 / Hornet 600 / CBR 600F the lever might jam with the mirror support.
- If so, the mirror support needs to be shortened about 1 mm from underneath. Black cutting edge with a paint stick or a permanent felt-pen afterwards.

4 Final Checking

- Finally check function and fixation of all parts. Test front wheel for easily revolving and brake response. Check clutch for function and adjustment as well as brake- and clutch-switch.
- A test-ride is necessary now! Afterwards, check function and fixation of all parts again. Test front wheel for easily revolving and brake system for overheating. One more time check clutch for function and adjustment as well as brake- and clutch-switch.
- Check function of lightning system, particularly the brake light!
- Check function of all switches of both levers!
- Check function of brake system and clutch system in all 6 settings!

5 Maintenance

- Never use aggressive care- or cleaning products on synto-levers, if in doubt test product at an invisible spot for applicability. Omit forthright cleaning with high-pressure cleaners or degreasers.
- All movable parts should be maintained regularly, with a non-resinous low-viscosity oil (e.g. Ballistol, WD40, etc.), especially after a longer ride in wet conditions.
- Check all parts regularly to be free of play and movable, according to the vehicle manufacturer's instruction. Replace damaged parts immediately, otherwise a proper functionality can't be granted and their might be a risk of serious injuries.

Eine deutsche Version ist ebenfalls verfügbar. Siehe: www.ab-m.de